



RETA

Gradevinske skele





Visoko kompatibilni profesionalni sistem građevinskih skela.

Karakteristike građevinske skele

Svi elementi građevinske skele mogu se slagati po potrebi u cjeline uz primjenu svih standarda sigurnosti na maksimalnu visinu građevinske skele do 24 metra i dostupne su u aluminijskoj i čeličnoj verziji s više mogućnosti kombiniranja materijala podova.

Čelik



ČELIK

Aluminij



ALU

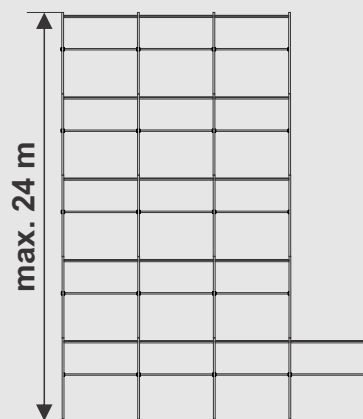

Modeli građevinskih skela

Model L

kompatibilno s Layher sistemom skela

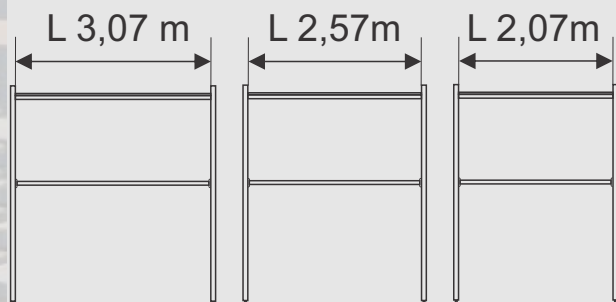

Model P

kompatibilno s Plettac sistemom skela

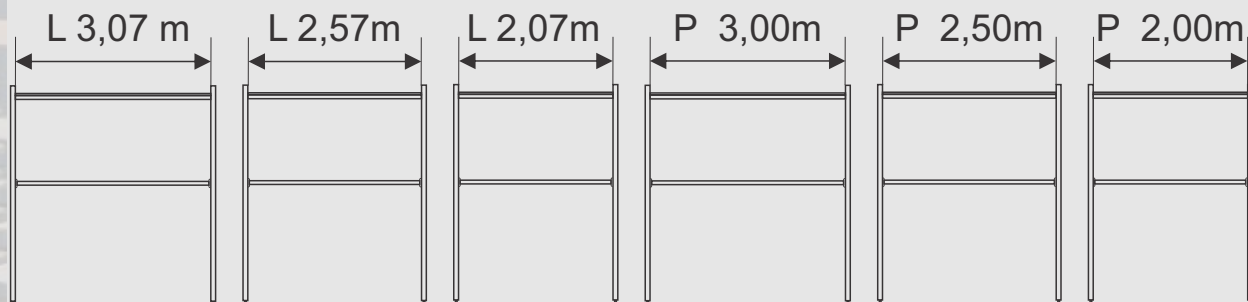

Certifikati

Građevinske skele certificirane su za hrvatsko tržište i zadovoljavaju norme EN 12810-1, EN 12811, EN 10204 te CEE 97,23. Uz to posjeduju i certifikat sigurnosti B i švedski certifikat S. Ovi certifikati priznaju se u većini europskih zemalja. U svojoj ponudi također imamo skele koje imaju njemački certifikat „DiBt Zulassung”, koji je neophodan za korištenje skela u Njemačkoj.

Komponente građevinske skele - Model P

MODEL
P

OKVIRI



Model P okvir



Model P okvir



Okvir ograde početak/završetak



Okvir ograde početak/završetak

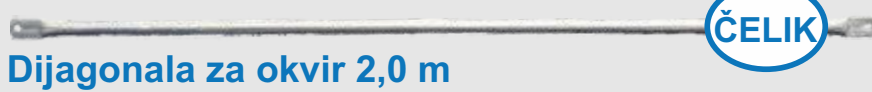

Dijagonala za okvir 2,0 m



Dijagonala za okvir 2,5 m



Dijagonala za okvir 3,0 m

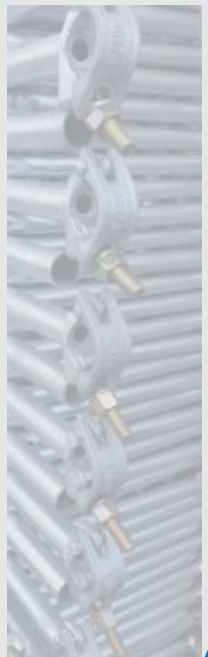
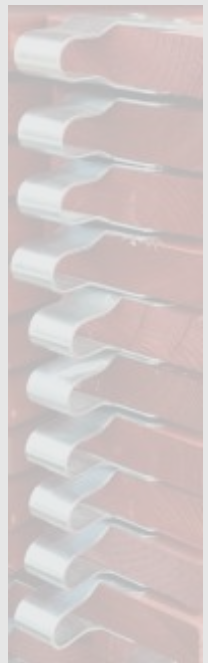

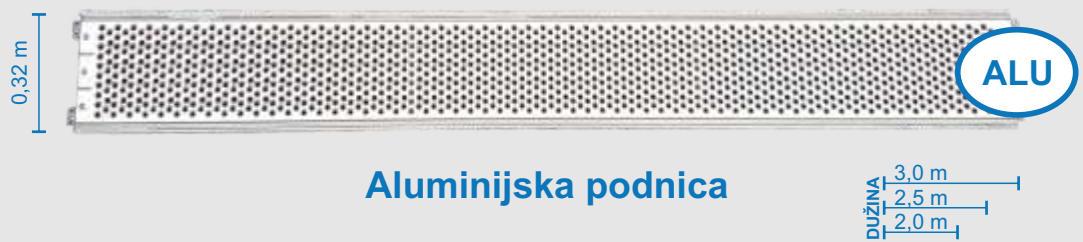

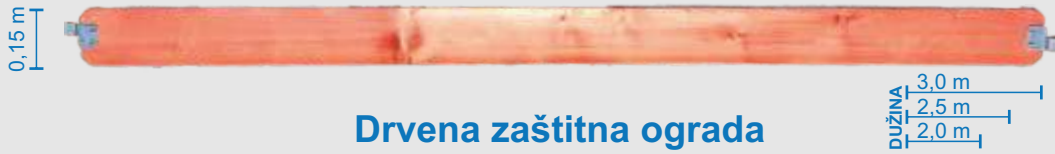

Drvena zaštitna ograda



Jednostruka zaštitna ograda



Dvostruka zaštitna ograda

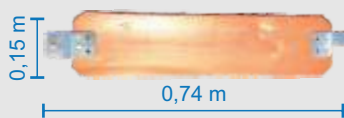

Drvena zaštitna bočna ograda



Bočna ograda

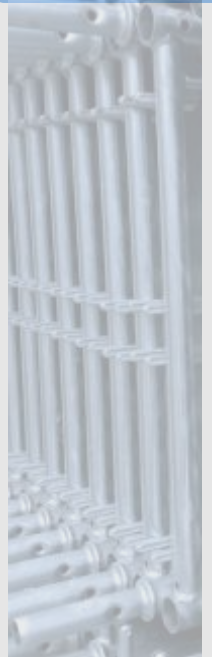

O
G
R
A
D
E

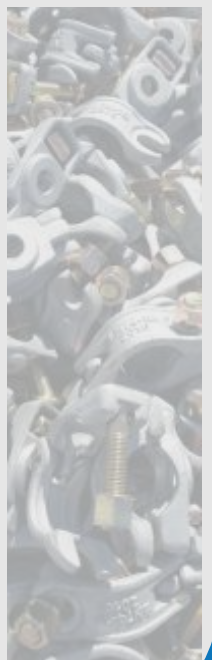

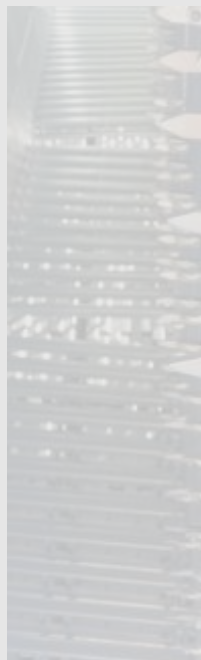

**S
T
U
P
O
V
I**



ALU

Središnji L stup



ČELIK

Središnji L stup



ČELIK

Konzola

DUŽINA 0,76 m
VUŽINA 0,32 m



ČELIK

Središnji stup



ČELIK

Stopa



ČELIK

Ukruta i tipla za zid



Priključnica



Priključnica ograde



Okretna Priključnica



Niži početak dijagonale



ALU

Stepenice s ogradom



ALU

Ljestve

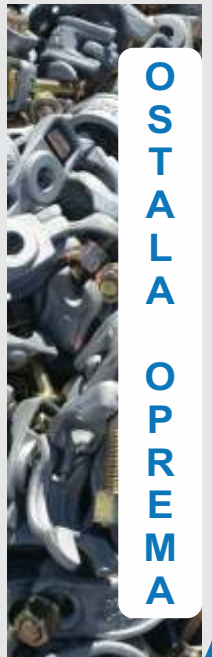
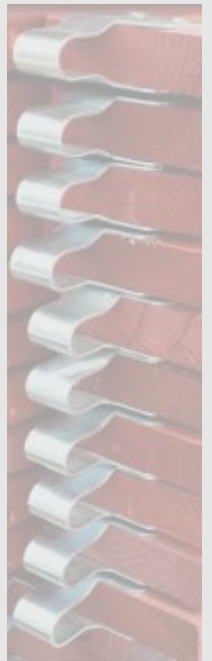
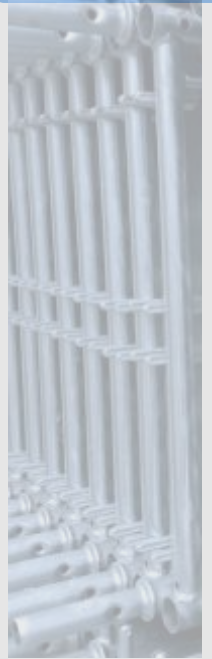

OSTALA
OPREMA

www.reta.hr

Naši proizvodi za vaš uspjeh



Reta d.o.o. Zagrebačka ulica 15K, 47 000 Karlovac • www.reta.hr • reta@reta.hr
Odjel metala tel: 047/ 637 751 • fax: 047/ 637 766 • email: metali@reta.hr
OIB:01201898816 VAT ID: HR01201898816 IBAN: HR2824000081190007387

